

PROCHANNEL slope profile

Stainless steel, 1.4301 (V2A)

Wedge-shaped stainless steel profile for facing the slope produced when installing drainage lines

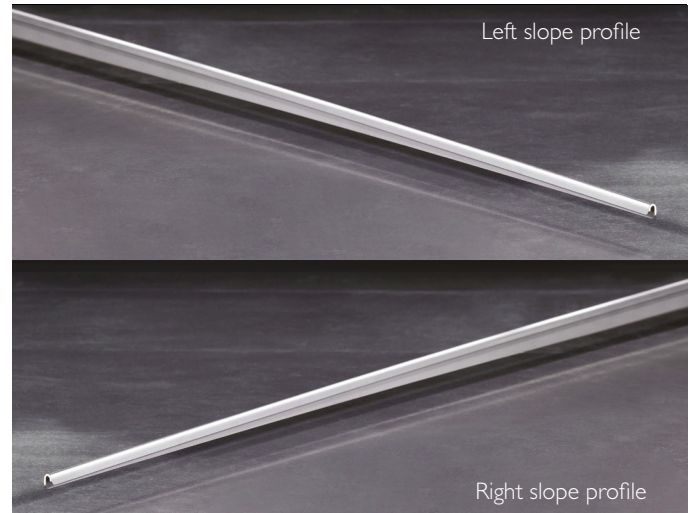
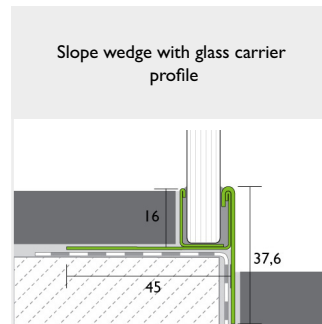
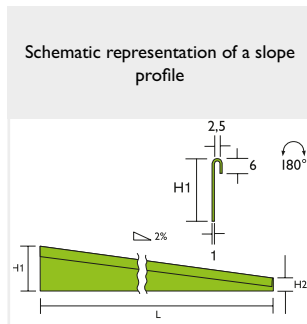

Use and applications:

The PROCHANNEL slope profile made of stainless steel, 1.4301 (V2A) is an aesthetically sophisticated wedge-shaped profile developed to face the surface that is created when forming the slope of 2% produced when installing a drainage line.

The PROCHANNEL slope wedge can be installed on a wall or in the floor.

As the PROCHANNEL slope profile is incorporated during the tile laying work, the compound seal is protected on the wall and floor areas at the same time.

The PROCHANNEL slope profile is designed in such a way that it can be built in securely in the wall as well as in the floor using the PROCHANNEL glass carrier or the PROFLOOR angle profile.

Advantages:

- PROCHANNEL slope profiles are simple to install
- An elegant and designer-orientated facing solution
- High-quality material, 1.4301 (V2A stainless steel) with a brushed surface
- Protected from mechanical effects
- Available in a version with and without mortar carrier as well as left and right variants
- Time-saving as there is no requirement for cutting / chamfering of wall tiles

Delivery:

Profiles with protective film, individually shrink-wrapped. Packed in outer packaging for transportation.

| | |
|--|----------|
| Packaging unit | 1 unit |
| Customs tariff number, stainless steel | 73269098 |

Quantities and packaging units are available on the price list, the relevant price sheets or new product sheets, or please enquire with your specialist dealer.

Technical data:

| | | | |
|---------------|----------------------------------|------|------|
| Material: | Stainless steel, 1.4301, brushed | | |
| Length [m] | 1.0 | 1.48 | 1.95 |
| Height 1 [mm] | 28 | 37.6 | 38 |
| Height 2 [mm] | 8 | 8 | 8 |
| Width [mm] | 4.5 | 4.5 | 4.5 |

Storage and transport:

Transport and store in dry locations protected from frost, dirt and other foreign bodies. Do not weigh down the profile with loads, and preferably store to avoid any risk of deformation and for protection. Shrink-wrapped films profiles should be protected against the effects of sunlight / UV rays.

PROCHANNEL slope profile

Stainless steel, 1.4301 (V2A)

Environment and disposal:

Profiles removed from the elastic seals can be recycled as metals. Observe any official local regulations.

Additional products:



PROCHANNEL glass carrier profile made of brushed V2A
To take glass panels up to a thickness of 8-10 mm. Available in lengths of 1.00 m, 1.48 m or 2.10 m.

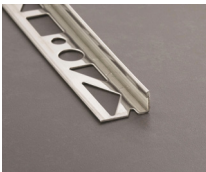

PROFLOOR angle profile made of brilliant V2A/V4A
Support profile for slope wedge. In lengths 1.00 m, 2.50 m or 3.0 m and heights of 3-30 mm.

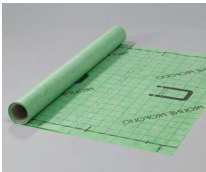

PROFOLIO sealing and decoupling film made of polyethylene
Fleece-laminated on both sides, certified by general building approval test certificate. Material thickness approximately 0.4 mm.

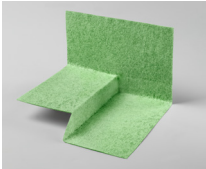

PROFOLIO balancing edges
PE film, fleece-laminated on both sides
Height compensation, approximately 20 mm



PROFIX DS barrier coating
Barrier coatings for compound sealing
2-component packages of 3.5 kg

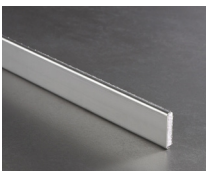

PROCHANNEL wall cover made of V2A brushed
With mortar carrier on the rear.
Available in heights of 25 and 35 mm.
Length 1.48 m



Ottocoll M500 Hybrid adhesive and sealing compound
IK adhesive and sealing compound based on STPU hybrid polymer in white

Laying / processing:

Preparatory work:/ construction site planning

The laying surface must be firm, dry, even, straight flush and/or level, free from release agents and solvents, and suitable for the use of the laying materials in question.

Processing:

Select the PROCHANNEL slope wedge according to the slope length / direction required. Check the profile for damage – only use undamaged profiles.

Remove the protective film from the exposed side of the profile before installing.

Floor laying

The PROCHANNEL slope wedge can be installed in the floor as required with the PROCHANNEL glass substrate profile or the PROFLOOR square-edged profile.

The height of the PROFLOOR angle profile selected should be 1 mm lower than the intended covering height of the adjacent tiling. If required, shorten the glass substrate profile or PROFLOOR angle profile according to the slope wedge length. If necessary, shorten the slope wedge to fit the retainer profile according to height 1 of the high side.

Use a suitable metal saw or cutting disc for cutting. Debur the cut edges.

When working with cutting discs or other tools, it is important to ensure that they are not used for or come in contact with iron or other grades of steel.

Fully incorporate the PROCHANNEL glass substrate profile or PROFLOOR angle profile with perforated arm into the fresh adhesive base. Affix the covering so that the upper edge of the profile closes flush with the upper edge of the covering (the profile should not be higher than the surface of the covering). Fill over the perforated fixing arm completely with tile adhesive. The different floorings must be laid fully embedded in the profile area. Apply tile adhesive or Ottocoll M 500 hybrid adhesive and sealing compound on the rear side of the slope wedge and hang and guide the slope wedge into the flank of the profile. Immediately after installing, the profiles must be cleaned of alkaline agents such as adhesive and grout.

The join between the covering and profile must be filled in completely with grout or silicone.

PROCHANNEL slope profile

Stainless steel, 1.4301 (V2A)

Wall laying

Apply tile adhesive or Ottocoll M 500 hybrid adhesive and sealing compound on the rear side of the slope wedge with mortar carrier and press and guide the slope wedge into the free slope surface.

Chemical and physical resilience:

In the case of chemical exposure, the chemicals and compounds to be used must be checked as to whether they have a corrosive or damaging effect on the material of the profiles. This also applies to cleaning agents and their appropriate measuring and use for maintenance cleaning.

After the adhesive and grout is fully hardened, the PROCHANNEL slope wedge must be mechanically resilient according to normal intended usage in the living area.

Cleaning devices and their brushes and inserts must be checked for damaging abrasive effects.

Basic cleaning / maintenance cleaning:

Clean only with pH-neutral agents that do not contain abrasive surfactants. Ensure there is no abrasive or scratching loading or cleaning. Stainless steel is an extremely resilient material, however, cleaning agents should not be allowed to dry it out unnecessarily. After cleaning, it should be therefore be rinsed with clear, clean water, as prolonged contact may otherwise cause damage.

Standards and regulations:

- ATV DIN 18352 Tiling and slab laying
- ATV DIN 18332 Natural stone laying
- ATV DIN 18157 Application of ceramic coverings using the thin-bed method
- DIN 18202 "Tolerances in building construction"
- ZDB (Central Association of the German Construction and Building Industry) data sheet, "Expansion joints" (latest version)
- ZDB data sheet, "Highly loaded floorings" (latest version)
- ZDB data sheet, "Compound seals" (latest version)
- Generally recognised rules for craft and technology
- Information point for stainless steel, www.edelstahl-rostoffrei.de, particularly MB 965 Cleaning of corrosion-resistant steels

Important notes:

- Iron particles from tools, scaffolds, means of transport, etc. must be removed immediately. Grinding dust, chips and welding spray from sheet metal work cause rapid corrosion when they coat stainless steel.
- When grouting with reactive resins, it is important to ensure in advance that the section surfaces will not be damaged and that excess grouting can be fully removed.
- Protective film should be protected from sun and removed with no residues before installation. Grout or adhesive should be washed off completely straight away.
- Regular use of effective materials in the correct concentration, constitution, combination and at the correct temperature is responsible for the chemical / physical resilience of the profiles. It is not possible to list them all here. Resistance to corrosion must therefore be checked and analysed in individual cases
- Chloride ions contained in fluids, condensates and chemicals have a corrosive effect. These stresses should be avoided or eliminated by being washed off thoroughly. For short-term stresses a concentration of 250 mg/litre should not be exceeded.

All details, references, notes, applicable specialist regulations, guidelines, standards and specialist knowledge are directed towards the German, and insofar as they are congruent, to the existing European regulations and training standards, irrespective of additional country-specific extensions or modifications. All our information is based on our experience and carefully performed tests. The variety of additional materials that might be used and differing construction and working conditions cannot be individually checked or influenced by us. The fulfilment of an outstanding service contract and the manufacturing of a demonstrable functional capability of the trades is therefore dependent on adhesion to the current VOB (German Construction Contract Procedures) regulations and recognised technological rules.

Our details do not preclude responsible planners and processors from their duty to independently assess the conditions of a building and suitable application of the products. In case of doubt, please seek technical application advice or carry out your own tests. The manufacturer's guidelines for laying and processing the surfacing material or the guidelines for other products used must be observed.

The publication of this product data sheet invalidates all previous product data sheets.

© Proline Systems 2017 – reproduction and passing on by our customers to their customers is permitted, insofar as there is a clear indication of our copyright. All other rights reserved.