

# PROCHANNELS-line

**Linear water drainage channel for primary or secondary drainage.  
Stainless steel channel body for aesthetic  
and practical deployment in wet rooms.**

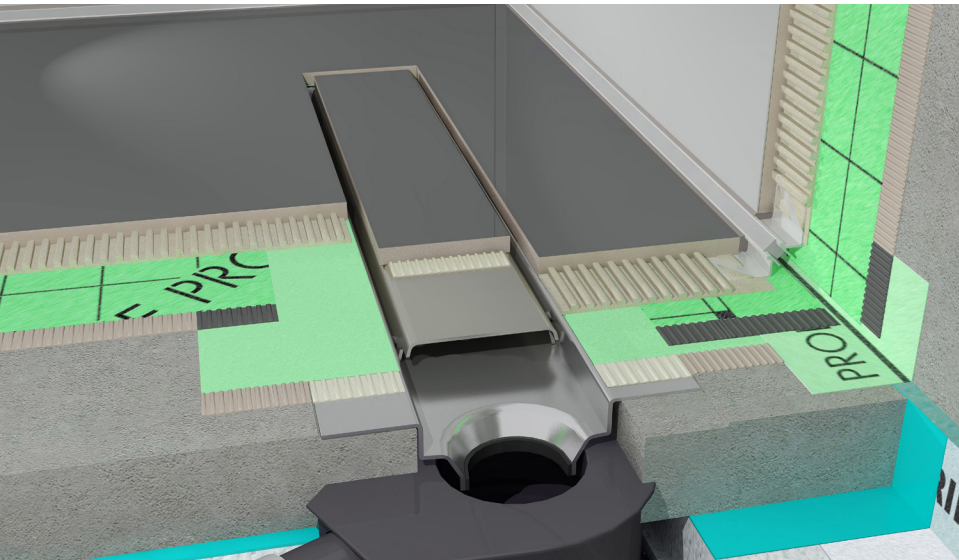

## Areas of application:

**PROCHANNELS-line** is a linear water drainage channel for barrier-free deployment in private or commercial wet rooms, such as:

- Domestic showers
- Barrier-free showers or showers with disabled access
- For floor drainage in rooms with high aesthetic finish
- Showers in saunas, swimming pools, sports centres
- Commercial sanitary areas
- Additional floor drainage in toilet systems
- Other wet rooms where floor drainage is installed to channel out water
- To separate water channelling areas from otherwise dry areas

**PROCHANNELS-line** satisfies the high demands for aesthetics while also providing a practical, simple slope for directing water. The linear drainage can be fitted by the wall, in the centre or at the entrance to an alcove or space. Floor surfaces that are practically free of slopes can be implemented using several drainage line housings or by employing custom solutions. This type of construction integrates and supports the drainage line housing in the screed structure.

## Product advantages:

If using large format tiles or natural stone, a spacious look can be achieved through an uninterrupted surface area free of valley cuts. The tile recess moulds the covering and drain into one unit. Six different design grilles allow you to set the creative tone. The support element enables the realisation of a frameless design in the form of a shadow gap. Standard lengths from 70 to 100 cm and the option of integrating several drainage line housings in a row offer extensive technical design variety.

**PROCHANNELS-line** captures surface water over its entire length and channels the water away.

Seep water in the screeding mortar can get into the drainage line at the bonding seal.

The installation is easy and quick. The one-sided, simple slope is created easily and effectively.

The type of installation makes it necessary to consider the needs of heat insulation and walking/impact noise. Different drain pans can be used to implement low installation heights in the washing area and to accommodate even larger amounts of water (e.g. high volume shower heads).

Thanks to the floor level shower installation, there is more space available and freedom to move.

# PROCHANNELs-line

PROCHANNEL coverings can support flat loads up to 300 kg. The height-adjustable frame enables the installation of coverings from 10 to 17 mm thick.

- Water channelling with the highest level of creative and aesthetic appeal
- Numerous creative opportunities
- Different lengths
- High drainage performance
- Easy to install
- Low fitting height
- Decoupled from noise and cold
- Provides more space and freedom of movement
- Hygienic, lightweight and easy to clean
- Can be installed with or without frame
- Frame can be used for coverings from 10 to 17 mm thick
- Creation of shadow gap using support element
- Protection from seep water inlet line
- Installation without any barriers



PROCHANNEL drain pan 2, side outlet with DN 50, drainage output of 0.8 l/s

## Product and accessories:

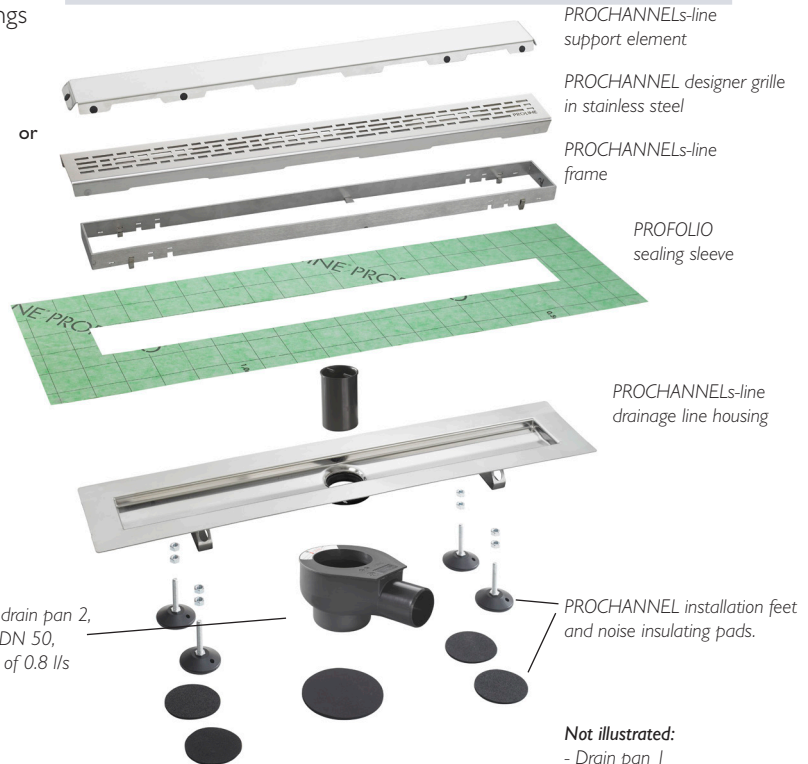

**Not illustrated:**  
 - Drain pan 1  
 - Drain pan 3  
 - "MAX" drain pan,  
 - Superflat drain pan

## Technical data:

### Materials:

Type of material for drainage line housing, frame, grille and recess:	Stainless steel, material code I.4301,V2A
Type of material for sealing sleeve:	Fleece-backed PE
Material type for drainage pans:	Plastic

### Dimensions and sizes:

#### Available drainage line lengths:

Available in lengths of 700 to 1000 mm with supplied or fixed sealing sleeve (glued).

Nominal length	Total length (L)	Visible dimension after installation (L - 87 mm)
700 mm	739 mm	752 mm
800 mm	839 mm	752 mm
900 mm	939 mm	852 mm
1000 mm	1039 mm	952 mm

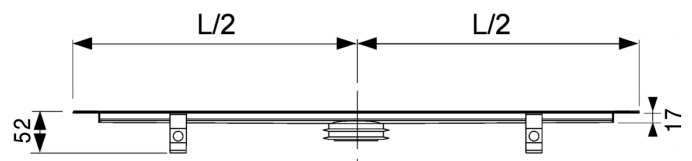
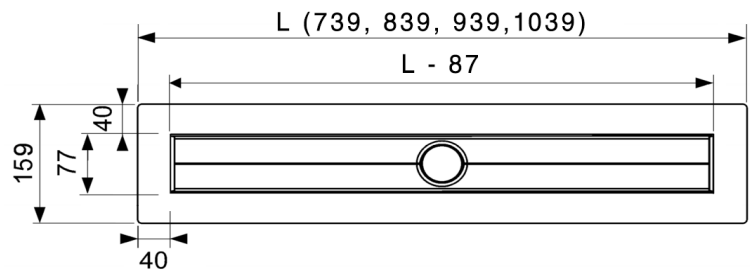

EDITION\_2016\_08\_AH\_LZ

# PROCHANNELS-line

## Frame:

Type of material	Stainless steel, material code 1.4301, V2A, polished face edge
Available frame lengths (mm)	652 / 752 / 852 / 952
Fits drainage line lengths (mm)	700 / 800 / 900 / 1000
Frame width	72.5 mm
Frame height	23 mm
Adjusts to covering heights of (mm)	10 / 13 / 15 / 17

Delivery includes height adjustment bases.

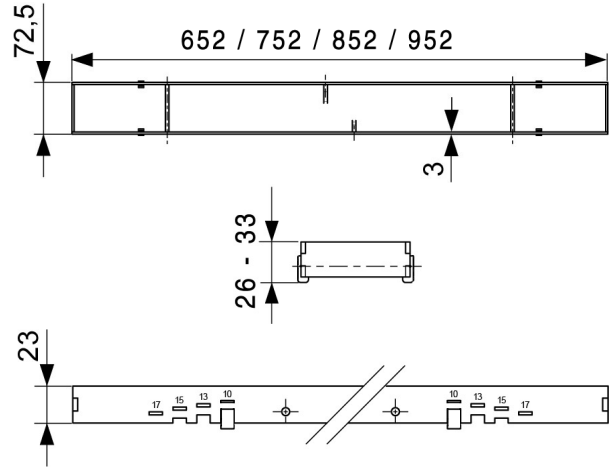

## Support element:

Type of material	Stainless steel, material code 1.4301, V2A
Fits drainage line lengths (mm)	653 / 753 / 853 / 953
Fits drainage line lengths (mm)	700 / 800 / 900 / 1000
Support element width	76.5 mm
Support element height	13.5 mm

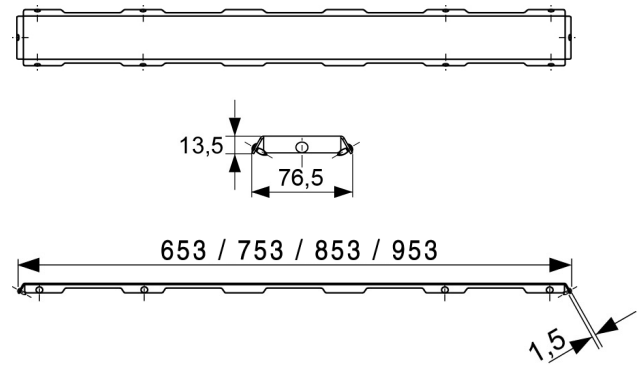

Tile recess and design grilles:	Tile recess	Steel design grille	Classic design grille	Flower / Linear / Cross / ZigZag design grille
Nominal length	700 - 1500 mm	700 - 1000 mm	700 - 1500 mm	800 and 900 mm
Material	V2A, with polished face edges	V2A in enclosed steel design with brushed surface	V2A polished	V2A polished
	For on-site bonding of tiles with Ottocoll M500 (check adhesive compatibility with tile)			
	Can be subjected to load class K3, test load of 300 kg	Can be subjected to load class K3, test load of 300 kg	Can be subjected to load class K3, test load of 300 kg	Can be subjected to load class K3, test load of 300 kg



For the latest information and item numbers, please refer to our price list. The list is available as a download in our service section at [www.proline-systems.com](http://www.proline-systems.com).

# PROCHANNELs-line

Drain pans:	Drain pan 1	Drain pan 2	Drain pan 3	"MAX" drain pan	Superflat drain pan
Drainage rate (acc. to DIN EN 1253)	0.70 ltr/sec	0.80 ltr/sec	1.30 ltr/sec	1.20 ltr/sec	0.50 ltr/sec
Outlet	Horizontal, DN 50	Horizontal, DN 50	Vertical, DN 50	Horizontal, DN 70	Horizontal, DN 40
Minimum installation height	84 mm	110 mm	possible from 17 / 52 mm**	138 mm	59 mm
Art. No.	95340	95341	95342	95344	95343
Sealing water height	25 mm	50 mm	50 mm	60 mm	30 mm
Acc. to standard	No	Yes	Yes	Yes	No
Specific use	Renovation	Standard	For free choice of ceiling opening/pipe feed	Increased volume of water	Renovation
Rotatable by 360 degrees	Yes	Yes	Yes	Yes	No

(\*) smallest installation height = measured up to fixed flange

(\*\*) 17/52 mm without / with foot bracket

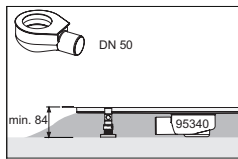

Drain pan 1

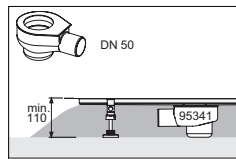

Drain pan 2

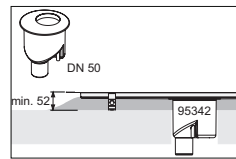

Drain pan 3

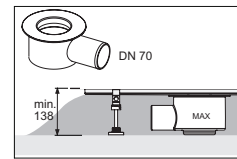

"MAX" drain pan

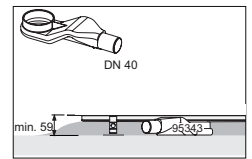

Superflat drain pan

Supply rating, hand shower head(\*) Approx. 0.10-0.30 ltr/sec  
 Supply rating, ceiling shower head(\*) Approx. 0.33-1.33 ltr/sec  
 Supply rating, high volume shower head(\*) Approx. 0.33-1.50 ltr/sec

(\*) The supply rating depends on the type and number of shower heads, the available water pressure, size of supply lines as well as upstream fittings (e.g. thermostat or the like). The total supply rating should be requested from the construction engineer, planner or fitter if several shower heads, ceiling shower heads (also called RainSky) or high volume shower heads are to be installed in the same shower area.

### Sealing sleeve dimensions:

Head protrusion	Approx. 6.5 cm passed flange
Longitudinal protrusion	Approx. 6.5 cm passed flange
Total width	Approx. 28.8 cm
Total length	Channel length (L) + 13 cm

### Storage and transportation:

Store and transport dry in an enclosed container protected against sunlight, UV rays, dirt, impact, abrasion and other foreign matter. Storage and transportation over longer distances should be in an laying position. To avoid any risk of deformation, do not place any load on the container.

### Environmental protection and disposal:

Dispose of the packaging material as stipulated by law and regional ordinances.

### Supplementary products:

<b>PROCHANNEL installation feet</b>	Mounting feet for simple height adjustment of the drainage line. Soundproof Adjustment range for bottom edge of feet to head = 90 - 110 mm
Delivery form	per set (4 installation feet including sound-absorbing underlay for drain and feet) Art. No. 95350

<b>PROCHANNEL sound insulation mat</b>	Underlay mat for reducing installation noise and impact sounds according to DIN 4109/A1 and VDI 4100
Material	rubber granulate bonded with PU
Size	1250 x 1250 mm
Thickness	approx. 6 mm
Delivery form	per piece Art. No. 95351

<b>PROFOLIO sealing and decoupling foil</b>	Polyethylene film laminated with thermal PP fleece layer on both sides
Colour	Green
Width	approx. 1.0 m / approx. 0.4 mm thick
Rolls with	5 m Art. No. 93501
Rolls with	30 m Art. No. 93502

For more information, please refer to the system data sheet.

# PROCHANNELS-line

<b>PROFOLIO sealing tape</b>	Highly flexible, transverse-elastic tri-laminate fleece-backed on both sides	
Colour	Green	
Thickness	approx. 0.7 mm	
Total width	approx. 120 mm (+/- 2 mm)	
Rolls with	50 m (with scaling )	Art. No. 93131
Rolls with	10 m	Art. No. 93141

<b>PROFOLIO Sealing tape corners</b>	Highly flexible, transverse-elastic tri-laminate fleece-backed on both sides	
Colour	Green	
Thickness	approx. 0.7 mm	
Total width	approx. 60 + 60 mm	
Leg length, inner corner	approx. 120 mm	
Leg length, outer corner	approx. 110 mm	
Each carton has	25 pieces	
Internal corner		Art. No. 93518
External corner		Art. No. 93519

<b>PROFOLIO sealing sleeves</b>	Highly flexible, transverse-elastic tri-laminate, fleece-backed on both sides	
Colour	Green	
Thickness	approx. 0.7 mm	
Wall collar with 15 mm hole punch		
Size	120 x 120 mm	
Carton has	25 pieces	Art. No. 93512
Floor collar		
Size	425 x 425 mm	
Carton has	10 pieces	Art. No. 93510

<b>PROFOLIO butt-joining tape</b>	Polyethylene film laminated with thermal PP fleece layer on both sides	
Colour	Green	
Width	approx. 15 cm / approx. 0.4 mm thick	
Rolls	25 m	
		Art. No. 93513

<b>PROFIX DS sealing gel</b>	Fast and elastically hardening 2-component sealing gel for bonding seal under ceramic coverings.	
Delivery form	Comp. A 1.75 kg sack Comp. B 1.75 kg canister in the mixing chamber	
		Art. No. 93784

For more information, please refer to the system data sheet or safety data sheets.

<b>Ottocoll M500 hybrid adhesive and sealants</b>	1-component hybrid polymer-based adhesive and sealant (STPU)	
Colour	White	
Delivery form	310 ml cartridge	
		Art. No. 93514

The technical bulletins of the manufacturer, Hermann Otto GmbH, must be observed.

## Installation options:

### PROCHANNELS-line with frame:

Height can be adjusted to four covering heights, mount for tile recess or design grille.

**OR**

### PROCHANNELS-line with support element:

For the version without a frame and creating a shadow gap.

#### Installing PROCHANNELS-line – by walls:

Place the channel by the wall > 6 cm from the flange. This enables sufficient installation space for secure connection of the sealing material and also facilitates noise decoupling.

#### Installing PROCHANNELS-line – by entrance:

If the shower area is an alcove separated from the remaining area, an expansion joint should be made along the stainless steel flange for usual technical reasons.

#### PROCHANNELS-line installation - side wall spacing:

It is recommended that the choice of channel length be made so that there is sufficient space at the side head sections for an uncut sealing sleeve and sealing tape.

Spacing approx. > 6 cm from flange.

#### PROCHANNELS-line – custom lengths:

Custom lengths can be supplied on request. Supply will depend on the quantity and feasibility of production. Custom parts require adequate lead time to manufacture.

#### Increasing drainage performance:

If a higher drainage capacity is required as a result of the planned installation, this can be achieved with the "MAX" drain pan, an additional channel or a custom channel with two drain outlets.



# PROCHANNELs-line

## Connecting with HT socket pipes:

Drain pans 1 to 3 and the "MAX" drain pan can be rotated 360° and connected from all sides. The outlets (DN 50/70) of the PROCHANNEL drain pans must be connected using suitable HT socket pipes, matching bends and lubricant to the drain/soil pipe. To allow a sufficient slope in the connected path, the drain on the building side should be located directly between the floor and wall or recessed in the floor:

## Reducing the installation height:

The channels can be fitted with and without installation feet. Installation feet with noise insulating pads are available as an accessory. The welded on foot brackets can be cut off if required using a suitable metal saw.

The requisite installation height is defined by the height of the drain pan and is at least 59 mm from the contact surface to the upper edge of the flange. If the supporting substrate in the area below the drain pan and along the pipe connections can be chiselled out or removed, the installation height is reduced to 52 mm (with foot bracket) or 17 mm (with detached foot bracket).

## Required slope:

Depending on the covering material used, with coarse even surface or fine even surface, the slope should be set so that water drains away quickly. Usually, slopes are set between 1 and 2 %. Taking into account the covering surface and the local conditions, the slope may deviate from this information.

## Surge inhibitor:

Surrounding the shower area with PRONIVO S transition and compensator profiles can double as a surge inhibitor to prevent water from overflowing to the outside.

## Potential compensation:

The drain pan is made from non-conducting plastic. Potential compensation, where necessary, should be carried out in accordance with DIN VDE 0100 T410.

# PROCHANNELS-line

# PROLINE

## Installation instructions:

The drainage line should always be integrated firmly in the screed mortar layer and is thereby held in the designated position.

### Installing on screed floors with noise insulating layers

#### (floating screed floor):

##### With installation feet:

- Screw on installation feet. Set-up **PROCHANNELS-line** with the feet on foam pads, align it so that it is even and secure it at the required height. Mark recesses for feet, drain pan and connecting pipe on the insulating material and cut out.
- To install, place the large noise insulating pad under the drain pan and the small pads under the installation feet. If necessary, dab a suitable quantity of mortar beforehand under the noise insulating pad to prevent the drain pan from slipping. As the mortar spreads under weight, no amount should escape over the noise insulating pad. Ideally, use a quick hardening mortar.
- Fit the connecting lines to the drain pipe using matching HT socket pipes (DN50/70). With approx. 10 ltr. of water (e.g. from a watering can), check the leak-tightness of the connections and pipe joints.
- Shroud the connecting line with a suitable insulating sleeve.
- Secure the channel bodies to prevent them from slipping.
- Lay out the noise and heat insulating material completely. Attach edge strips.
- Fill the remaining recesses using suitable insulating material or non-expanding 2-pack filling foam, for example. Cover the insulation with suitable separating layers and secure with adhesive tape at the joints and incisions. Fresh screed mortar above this must not find its way into the insulating layer.
- Pack the underside and area surrounding the drainage line housing with screed mortar and fill around up to the upper edge of the drainage line flange. Carefully compress the screed mortar in the shower area, scrape off at an angle for the slope and smooth down the surface. Check several times to make sure the drainage line housing is positioned level and in the right place.
- The protective EPS covering protects the inner drainage line

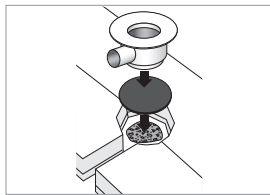

housing from contamination.

##### Without installation feet:

- The insulation must be completely secure against tipping and be in complete contact in the area under **PROCHANNELS-line**. If necessary, level out the area beforehand or bond down insulating material across as much of the area as possible at a later stage.
- Lay out and align **PROCHANNELS-line**. Mark a recess in the insulating material for the drain pan and connecting line and cut out. Fit the channel body and pack underneath (e.g. ceramic tile strips bonded with thin-bed mortar) to the required height and align.
- To prevent the drain pan from slipping, dab a suitable quantity of mortar under one noise insulating pad. Ideally, use a quick hardening mortar.
- Fit the connecting lines to the drain pipe using matching HT socket pipes (DN50/70). With approx. 10 ltr. of water (e.g. from a watering can), check the leak-tightness of the connections and pipe joints.
- Shroud the connecting line with a suitable insulating sleeve.
- Fill the remainder of the recesses with suitable insulating material or non-expanding 2-component expanding foam, for example. Cover insulation with suitable separating layers and secure with adhesive tape and film. Fresh screed mortar above this must not find its way into the insulating layer.
- Secure the channel bodies to prevent them from slipping.
- Pack the underside and area surrounding the drainage line housing with screed mortar and fill around up to the upper edge of the drainage line flange. Carefully compress the screed mortar in the shower area, scrape off at an angle for the slope and smooth down the surface. Check several times to make sure the drainage line housing is positioned level and in the right place.
- The protective EPS covering protects the inner drainage line housing from contamination.

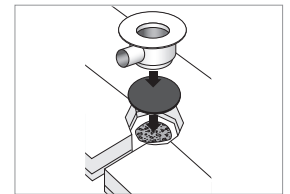

# PROCHANNELS-line

## Installing on screed floors with separating layer:

### With installation feet:

- Screw on installation feet. Set-up PROCHANNELS-line with the feet on the laid-out separating layer; align it so that it is even and secure it at the required height. The separating layer is protected if foam pads are used.
- To install, place the large noise insulating pad under the drain pan. If necessary, dab a suitable quantity of mortar on the noise insulating pad beforehand to prevent it from slipping. Ideally, use a quick hardening mortar.
- Fit the connecting lines to the drain pipe using matching HT socket pipes (DN50/70). With approx. 10 ltr. of water (e.g. from a watering can), check the leak-tightness of the connections and pipe joints.
- Shroud the connecting line with a suitable insulating sleeve. Attach edge strips.
- Secure the channel bodies to prevent them from slipping.
- Pack the underside and area surrounding the drainage line housing with screed mortar and fill around up to the upper edge of the drainage line flange. Carefully compress the screed mortar in the shower area, scrape off at an angle for the slope and smooth down the surface. Check several times to make sure the drainage line housing is positioned level and in the right place.
- The protective EPS covering protects the inner drainage line housing from contamination.

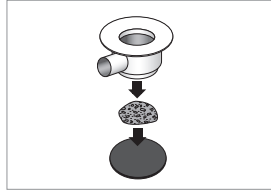

- Pack the underside and area surrounding the drainage line housing with screed mortar and fill around up to the upper edge of the drainage line flange. Carefully compress the screed mortar in the shower area, scrape off at an angle for the slope and smooth down the surface. Check several times to make sure the drainage line housing is positioned level and in the right place.
- The protective EPS covering protects the inner drainage line housing from contamination.

## Attaching the sealing sleeve:

- First make sure that the flange is free of all release agents (such as grease and oil). Remove any release agents using suitable cleaning agents.

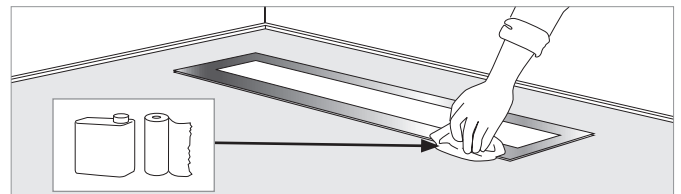

- Apply Ottocoll M500 hybrid adhesive and sealant.

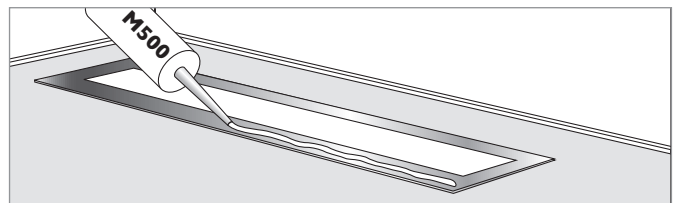

- Spread parallel to the drainage line housing using a suitable serrated spatula. Leave a gap of about 5 mm to the inside edge of the drainage line.

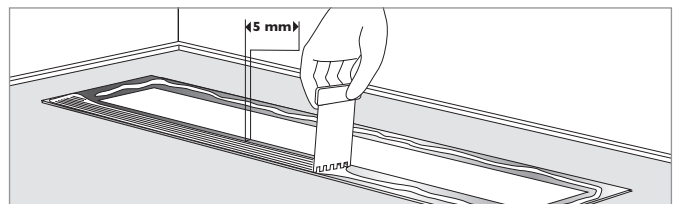

- Fold over the supplied sealing sleeve and press it firmly onto the flange.

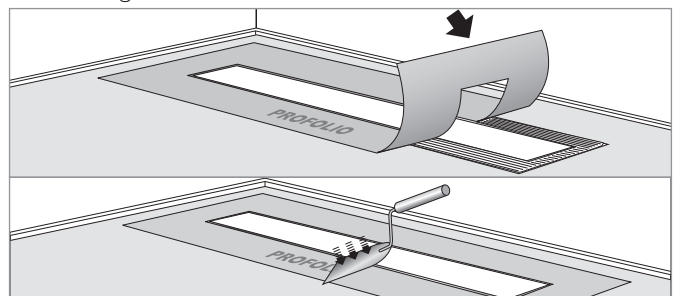

### Without installation feet:

- Set down the PROCHANNELS-line drainage line housing and shim it (e.g. using ceramic tile strips bonded with thin-bed mortar) to the required height and position above the laid-out separating layer.
- To prevent the drain pan from slipping, dab a suitable quantity of mortar underneath. Ideally, use a quick hardening mortar.
- Fit the connecting lines to the drain pipe using matching HT socket pipes (DN50/70). With approx. 10 ltr. of water (e.g. from a watering can), check the leak-tightness of the connections and pipe joints.
- Shroud the connecting line with a suitable insulating sleeve. Attach edge strips.
- Secure the channel bodies to prevent them from slipping.



# PROCHANNELS-line

# PROLINE

- e) Bond the sealing sleeve to the screed floor using PROFIX DS sealing gel, pressing down firmly so that full contact is made.

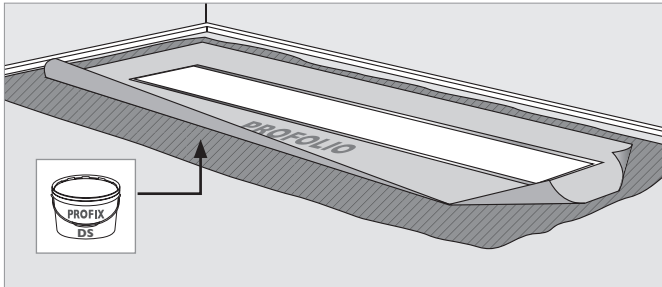

- f) Scrape away or smooth down any excess material that may escape.

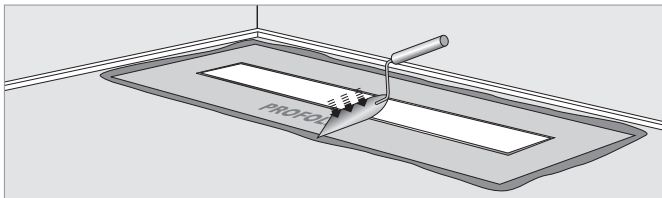

We recommend using **PROFOLIO** sealing and decoupling foil for sealing.

- g) Bond the **PROFOLIO** sealing and decoupling foil using thin-bed mortar (outside the underlying sealing sleeve) facing the screed so that full contact is made. Bond the overlapping area between the sealing sleeve and **PROFOLIO** sealing and decoupling foil using **PROFIX DS** sealing gel so that full contact is made. Scrape away escaping sealant.

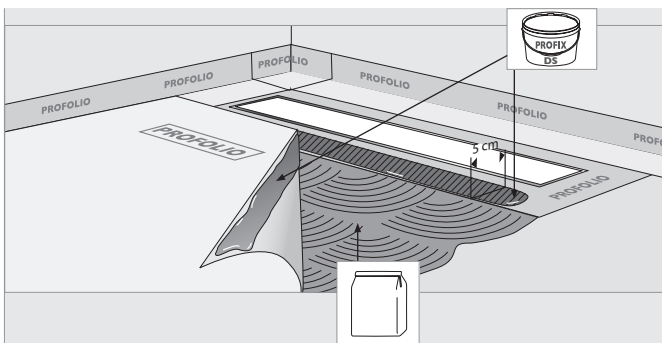

## Installing a PROCHANNELS-line frame:

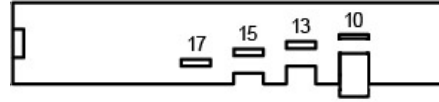

The installation height of the frame depends on the covering thickness. The frame comes with four setting options, which are indicated by the respective grooves. Latch the clip into the selected groove from the inside depending on the covering thickness. Place the frame into the drainage line housing. Create the covering with a gap of 3 mm to the frame. Pay attention to the evenness with respect to the upper edge of the frame. Elastically close the gap between the tile flooring and the frame.

**or**

## Installing a PROCHANNELS-line support element:

Lay the covering in the shower area up to the inside edge of the drainage line. Bond the cut-to-size covering material to the support element using Ottocoll M500. Create a shadow gap width of 6 to 8 mm. Make sure the edge is cut at a right angle.

## Cleaning

Use clean water, pH-neutral cleaning agent, a sponge or cleaning cloth. Ensure that there is no sanding or grinding effect. If necessary, clean grilles using suitable cleaning pastes. If necessary, use an alcohol-based cleaner or a cleaner especially developed for stainless steel or polishing paste. Perform routine cleaning regularly in accordance with local conditions. In places where substances containing chloride are used, regularly clean standing water also outside of the drainage lines and grilles to prevent concentrations from building up.

After cleaning, always rinse the surfaces with enough clean water to remove all cleaning agent residue.

Attention: Substances containing chlorine cause stainless steel to rust.

# PROCHANNELs-line

## Cleaning utensils

Cleaning utensils such as brushes, cleaning pads, microfiber cloths etc. must not be abrasive. Use commercial cleaning sponges (not containing iron) for stubborn dirt. Iron-containing scrubbing sponges, steel wool and steel brushes must never be used, since they can implant foreign iron particles into the stainless steel, which then will rust. For brush-finished surfaces (2G, 2J, 2K according to DIN 10088/3), always move the cleaning utensil in the direction of the grind.

## Cleaning the PROCHANNEL drain pan

### General information

Long hair and coarse dirt can get stuck in the stench trap. We recommend removing the grille/recess and the black standpipe underneath at regular intervals to perform an inspection at least once a month and, if necessary, remove the dirt. The intervals will depend on the number of showers taken, the amount of hair and the general degree of contamination. Determine the necessary intervals based on your own inspections.

### Procedure:

1. Remove cover
2. Remove black standpipe from the recess
3. Remove hair and coarse dirt from the open drain pan
4. Clean drain with a sponge or brush
5. Thoroughly rinse the drain
6. Reinsert the standpipe
7. Fill the stench trap with water
8. Put the cover back on

## Chemical and physical resilience:

Before using cleaning agents or collected water, check whether they have a corrosive or damaging effect. Avoid contact with substances containing chloride ions, strong acids or alkalis. Stainless steel reacts with oxygen in the air and forms a protective layer that becomes damaged upon abrasive contact with normal steel or iron and flying sparks from welding and cutting work, thereby resulting in corrosion. Once the adhesive, grout and filling compound has hardened completely, the drainage line can be subjected to mechanical loads as per its intended use.

# PROCHANNELs-line

## Important information:

- The linear drainage system was developed and designed for indoor wet rooms. It should not be used in outside areas.
- The stainless steel flanges of the drainage line are a supporting element and important for the seal. By no means should they be cut off, even due to spatial restrictions. Design the slope dimensions so that heights formed from overlapping sealing tape, sealing sleeves, sealing membranes and grout do not prevent water from draining.
- The drain pan must be secured underneath to prevent it from slipping. This can be achieved up to the height of the insulating material by foaming under and/or around using a suitable expanding foam.
- On slopes > 2 % there is a risk of falling from slipping over. The greater the slope, the lower the walking and standing comfort.
- If a high volume shower head or "RainSky" is used, it can be assumed that there will be an increased amount of water flow. In case of doubt, enquire about the intended installations and their supply rating from the client or planner so that the drainage line and performance can be adapted.
- Sealing water height describes the level of water that remains in the drain pan and acts as a barrier against unpleasant odours. As a rule, 50 mm are prescribed for this purpose. In the event of renovation or with low installation heights, it may be necessary to use a lower drain pan with lower sealing water height.
- If the level is too low, there is a chance of the sealing water being drawn out through the hydraulic effect of the draining water or, over time, the sealing water could evaporate. Unpleasant odours from the sewage system could find their way into the room through the empty drain pan. Adding 1/2 litre of water can remedy this problem.

## Standards and regulations:

Aside from all the relevant and currently applicable bulletins, standards and directives, the information listed as follows is recommended:

- DIN 18352 Tile and slab laying work
- DIN 18332 Natural stone work
- DIN 18333 Cast stone work
- DIN 18353 Screed work
- DIN 18195 Building seals
- DIN 18202 Tolerances in building construction
- DIN 18560 Screeds in building construction
- DIN EN 13813 Screed mortar and screed masses
- Bulletins from German Association of Screed and Flooring
- Bulletins from Association of Tiles and Natural Stone in the Central Association of the German Construction Industry, in particular:
  - Joint sealing
  - Outside flooring
  - Expansion joints
  - Substrates in damp rooms
- Interface co-ordination of heated underfloor structures
- ZDB tile and slab information "Information on decoupling"
- German Natural Stone Association – Building information about natural stone
- DIN 18024 Parts 1-2: Barrier-free built environment / Streets, squares, paths, public transport, recreation areas and playgrounds / Design principles (1996 - 1998)
- DIN 18040 Part 2: Construction of accessible buildings - Design principles - Dwellings (2011)
- DIN 4109 (1998): Sound insulation in buildings; requirements and testing, Amendment A1 (2001)

*All information, references, instructions, basic engineering principles, regulations, standards and expertise are based on German and largely equivalent European regulations and training standards, irrespective of additional country-specific supplements and amendments.*

*All our specifications are based on our experience and careful analysis. We are unable to examine or influence the diversity of associated materials used and the various construction site and processing conditions in detail. Fulfilment of an imposed work order and verifiable functionality of the object therefore depends on the observation of current VOB rules and the recognised rules of technology.*

*Our details do not absolve the accountable planner's and fitter's obligation to assess - on their own authority - the building conditions and practicability of the products. In case of doubt, carry out your own tests or seek technical application advice. Please refer to the laying and processing guidelines of the floor covering manufacturers or the manufacturers of associated products.*

*All previously published product data sheets cease to apply on publication of this product data sheet.*

© Proline Systems 2016 – We grant our customers the permission of reproduction and transfer to their customers, provided that clear reference is made to our copyrights. All other rights reserved.